

# STAR TREK™

THE OFFICIAL STARSHIPS COLLECTION



SPOCK'S JELLYFISH SHIP  
SPECIAL ISSUE

SCIENCE VESSEL

LAUNCHED: 2387

LENGTH: 36 METERS

RED MATTER INJECTOR

# SPOCK'S JELLYFISH SHIP

# Contents

04: PROFILE: SPOCK'S JELLYFISH SHIP

06: DESIGNING THE SHIP

## Stand assembly:

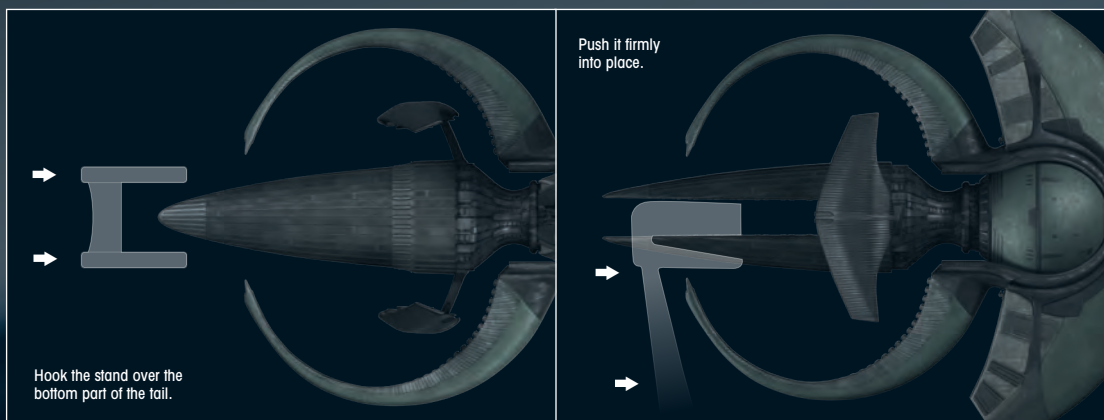

## EAGLEMOSS COLLECTIONS

Eaglemoss Publications Ltd. 2016  
1st Floor, Kensington Village, Avonmore Road,  
W14 8TS, London, UK. All rights reserved.

™ & © 2016 CBS Studios Inc. © 2016 Paramount Pictures Corporation. STAR TREK and related marks and logos are trademarks of CBS Studios Inc. All Rights Reserved.

Development Director: Maggie Calmels

YOUR COLLECTION STAR TREK – The Official Starships Collection is published fortnightly.

### DON'T MISS AN ISSUE

To make sure you receive every issue, take out a subscription and get STAR TREK – The Official Starships Collection delivered direct to your door or place a regular order with your magazine retailer.

### SUBSCRIPTIONS

When you subscribe you will receive exclusive free gifts! To subscribe:  
Visit our website at [www.startrek-starships.com](http://www.startrek-starships.com)  
Call our hotline 0844 493 6091  
Post the subscription form (which you will find inside issues 1, 2, 3, 4 & 5)

### BACK ISSUES

To order back issues: Order online at [www.startrek-starships.com](http://www.startrek-starships.com) or call 0844 493 6091

UK distributor:  
COMAG Magazine Marketing

### UK CUSTOMER SERVICES

Call: 0844 493 6091  
Email: [startrek-ship@eaglemoss-service.com](mailto:startrek-ship@eaglemoss-service.com)  
Write to: STAR TREK – The Official Starships Collection, Database Factory, Unit 4, Pullman Business Park, Pullman Way, Ringwood, Hampshire, BH24 1HD

### Australia

Call: (03) 9872 4000  
E-mail: [bissett@bissettmags.com.au](mailto:bissett@bissettmags.com.au)  
Write to: STAR TREK – The Official Starships Collection, Bissett Magazine Service Pty Limited, PO Box 3460 Nunawading, VIC 3131

### New Zealand

Call: (09) 308 2871  
Fax: (09) 302 7661  
Email: [subs@ndc.co.nz](mailto:subs@ndc.co.nz)  
Write to: STAR TREK – The Official Starships Collection, Netlink Subscriptions, PO Box 47-906, Pensonby, Auckland

### South Africa

Call: (011) 265 4307  
E-mail: [service@jacklin.co.za](mailto:service@jacklin.co.za)  
Write to: STAR TREK – The Official Starships Collection, Eaglemoss Publications Ltd, Private Bag 18, Centurion 0046

### Malaysia

Call: (03) 8020 7112  
E-mail: [sales@allscript.com](mailto:sales@allscript.com)  
Write to: STAR TREK – The Official Starships Collection, Allscript Establishment (M) Sdn. Bhd. No. 16, Jalan TP 3, Taman Perindustrian SIME UEP, 47620 Subang Jaya, Selangor Darul Ehsan, Malaysia

### Singapore

Call: (65) 6287 7090  
E-mail: [sales@allscript.com](mailto:sales@allscript.com)  
Write to: STAR TREK – The Official Starships Collection, Allscript Establishment, 605A Macpherson Road, #04-04, Citimac Industrial Complex, Singapore 368240

### OVERSEAS BACK ISSUES

Place your order with your local magazine retailer.

Recommended age 14+.  
Warning! Collectable figurines.  
Not designed or intended for play by children.  
Do not dispose of in domestic waste.

 Find us on Facebook

Join us online for competitions, updates and more!



**STORE YOUR COLLECTION in these binders**

TO PLACE AN ORDER, GO ONLINE AND VISIT:

[www.startrek-starships.com](http://www.startrek-starships.com)

[www.startrek-starships.com](http://www.startrek-starships.com)



# SPOCK'S JELLYFISH SHIP

## SPECIFICATION

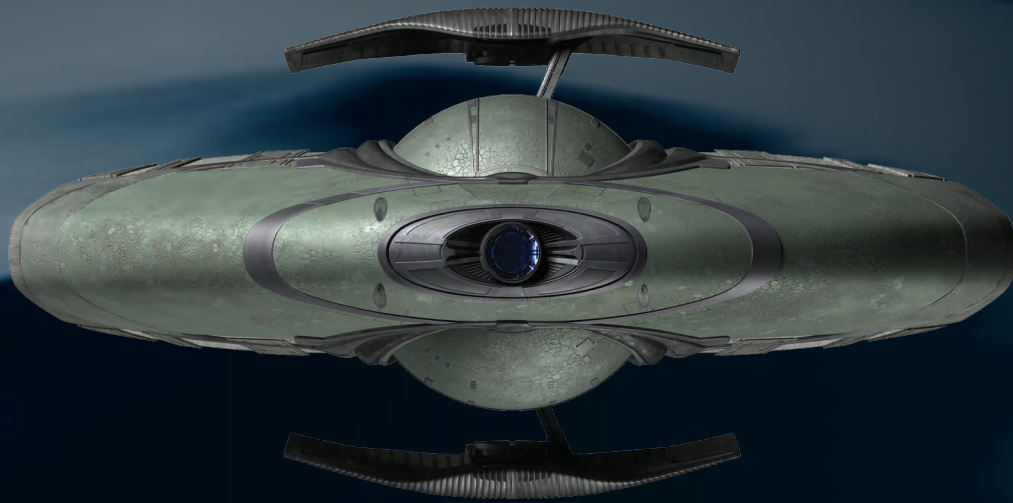

CLASS: EXPERIMENTAL

CONSTRUCTED: VULCAN

LAUNCHED: 2387

PILOT: SPOCK

CREW: ONE

WEAPONRY: RED MATTER INJECTOR

PHASERS, TORPEDOES

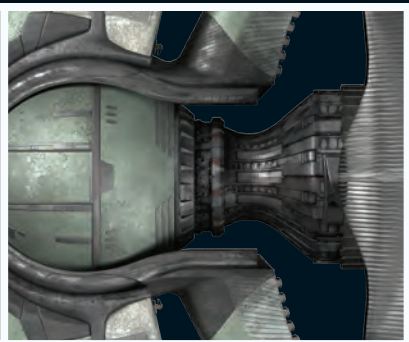
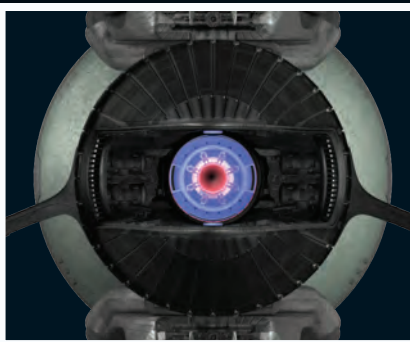



◀ The Vulcan ambassador Spock tried to use the ship to save Romulus from a supernova. After he failed, the Romulan Nero attacked him and he and the Romulan ship the *Narada* were sent back into the past.

The ship that Spock used to collapse the supernova that destroyed the Romulan star system was a small, one-man vessel that was constructed on Vulcan in 2387. When the Federation learned of the danger posed by the supernova, Spock promised the Romulans that he would save their planet. The Vulcan Science Academy outfitted their fastest ship with a red matter containment unit. The plan was to use the red matter to generate a black hole that would absorb the energy from the supernova and collapse it.

The ship was constructed around a cockpit with most of the interior given over to the red matter containment chamber. The rest of the ship rotated around this central axis. When it was in flight mode, the front part of the ship was in a vertical orientation, but when it landed this part rotated through ninety degrees with landing gear and an entrance ramp extending from what had been the side. The cockpit consisted of little more than a command chair and a control console, with

commands inputted from twin hand consoles on either side of it. The computer was programmed to respond to Spock's commands and keyed to use voice print and facial recognition to identify him.

The Vulcan science ship, which was 54.25 meters long, was capable of high warp speeds and was extremely maneuverable at sublight. It was armed with phasers and photon torpedoes

The supernova destroyed Romulus before Spock could collapse it. He extracted a small amount of red matter and fired it into the supernova, generating a singularity that collapsed the supernova. Both Spock's ship and a Romulan vessel, the *Narada*, were pulled into the black hole and thrown back in time. The Romulan captain Nero blamed Spock for his planet's destruction, and once in the past he captured the ship and marooned Spock on the planet Delta Vega where he was forced to watch the destruction of Vulcan.

A younger version of Spock later retrieved the Vulcan vessel and used it to create another singularity that destroyed it and the *Narada*.

# JELLYFISH SHIP

Spock took a one-man Vulcan vessel to the Romulan star system in an attempt to save the Romulans.



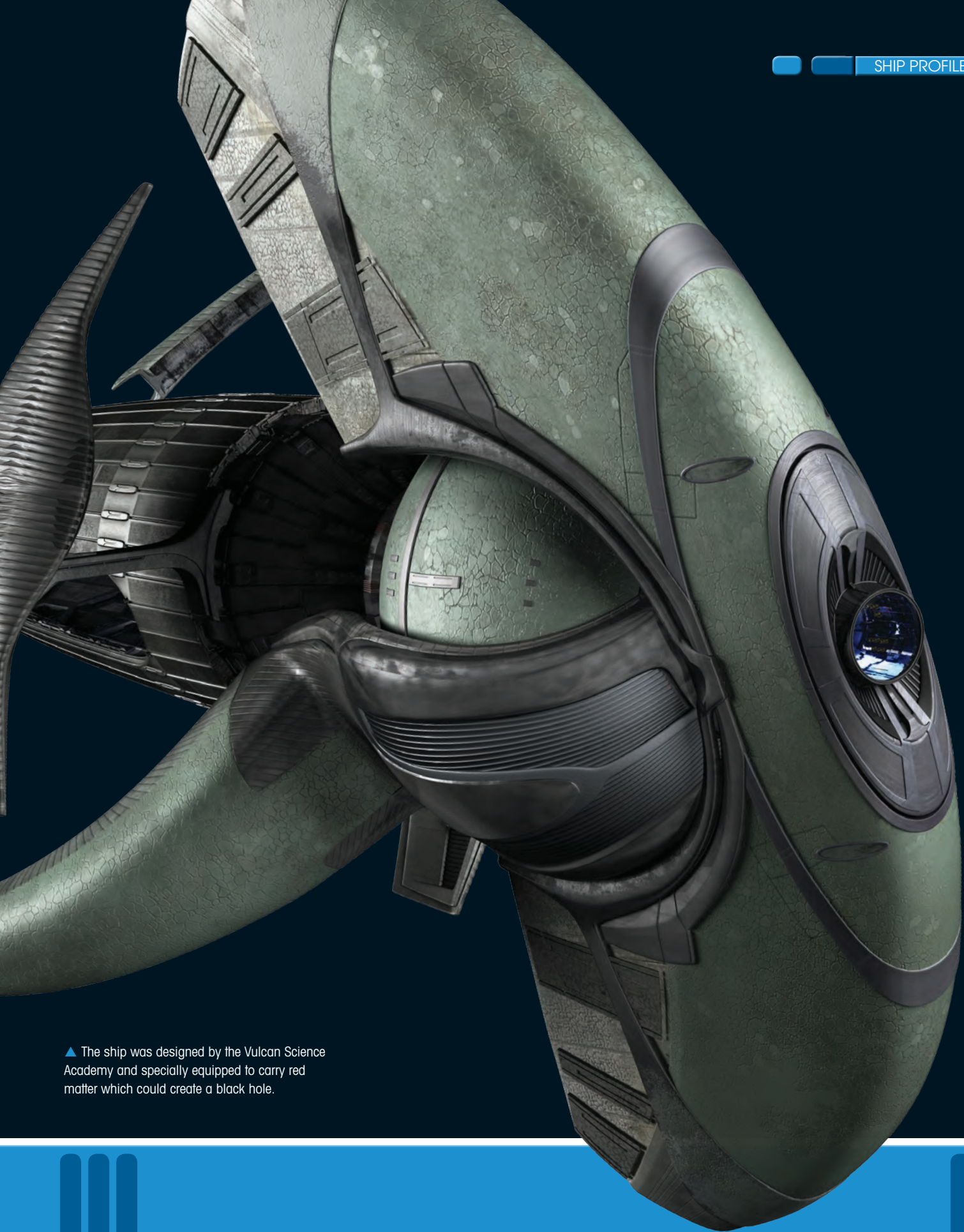

▲ The ship was designed by the Vulcan Science Academy and specially equipped to carry red matter which could create a black hole.





# DESIGNING THE **JELLYFISH**

Spock's ship was unlike anything we'd seen before—  
an organic Vulcan ship, modelled on a gyroscope.



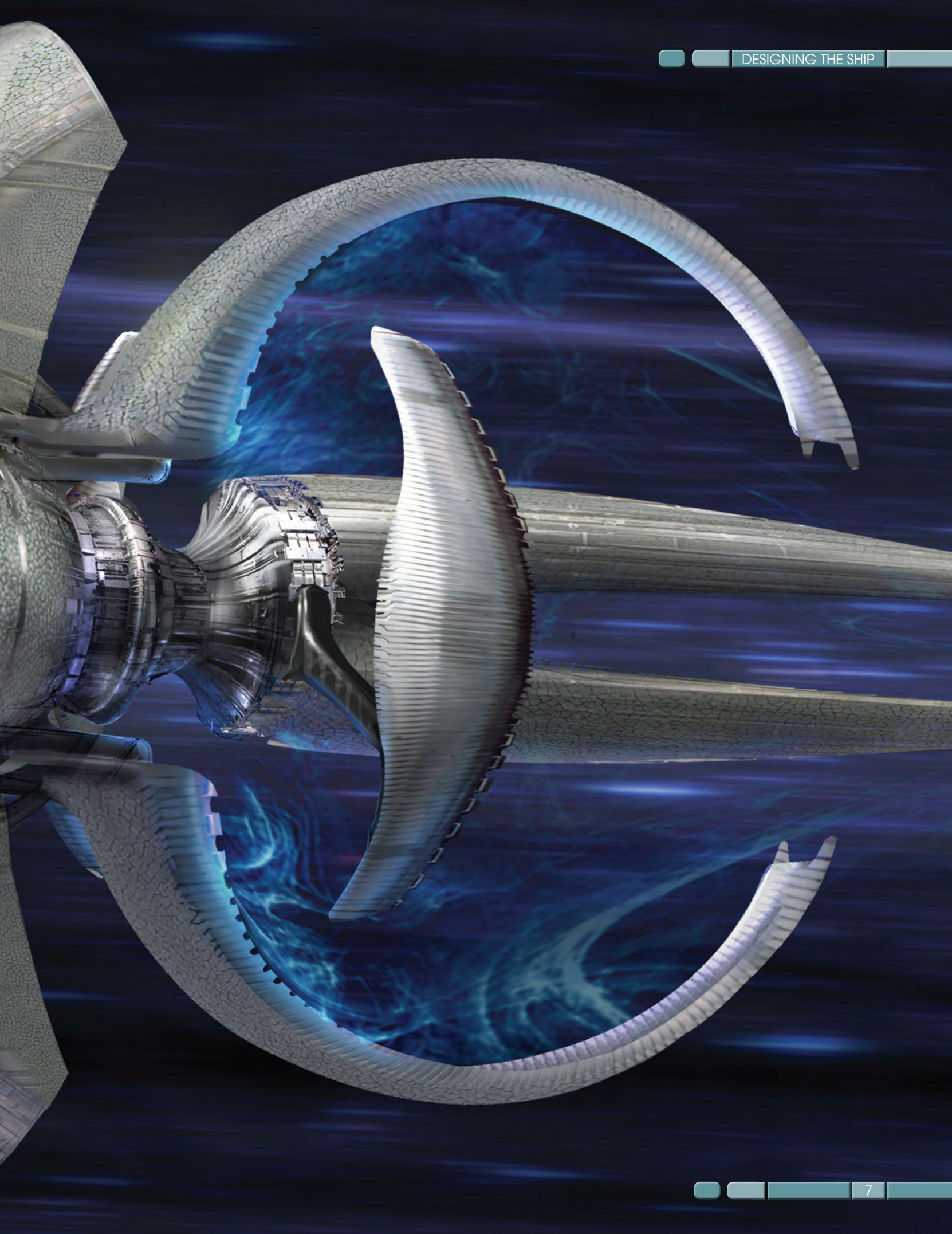



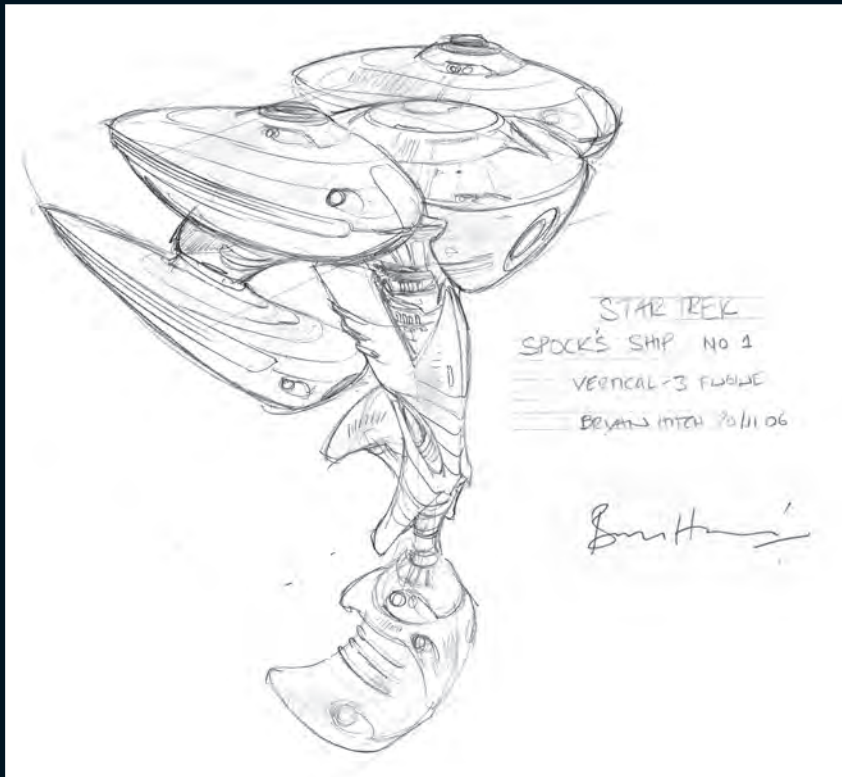

Work on Spock's ship began long before there was a script. Director JJ Abrams was working on the story with Alex Kurtzman, Robert Orci and Damon Lindelof and while many things would change they already had the idea that Spock would travel back in time after a failed attempt to avert a disastrous supernova. This was a year or more before actual production started, but even then Abrams wanted to see what their ideas might look like. One of Lindelof's friends was a famous comic book artist who had played a major role in reinventing many of Marvel's super heroes for the 21st century, Bryan Hitch. Hitch also describes himself as a *STAR TREK* fan "to the core" so he was pleased when Lindelof asked him if he would be interested in working up some concepts.

"There was no script," Hitch remembers. "Damon sent me a very rough first draft of the story to read. All they knew was that Spock's ship had to carry the red matter and that was it. So I was designing it with pretty much nothing but that requirement. I knew that it was essentially a single-man Vulcan ship. That suggested a small, fast ship but one that was powerful enough to hold a huge quantity of black hole making red stuff."

#### A NEW DIRECTION

From the beginning Hitch wanted to design something that was unconventional. He says that *DEEP SPACE NINE* is his favorite modern *STAR TREK* show precisely because it pushed the boundaries of storytelling to new levels. So although he knew his way around *STAR TREK* he didn't feel the need to be bound by its traditional approach to starship design.

"I wanted something *not* like conventional Federation ships," he explains. "The key thing for me was that I wanted a ship that could move in an interesting way physically. I was very keen to try to establish movement in a way that was different from the usual left to right approach – the 'sailing ship' method – used in all the shows and films. Space offers such unlimited senses of what should be up or down."

◀ The earliest designs for Spock's ship were produced by comic book artist Bryan Hitch. He sent several sketches to Abrams who picked two which were then worked up as basic CG models by Hitch's long-time friend Neil Bushnell.



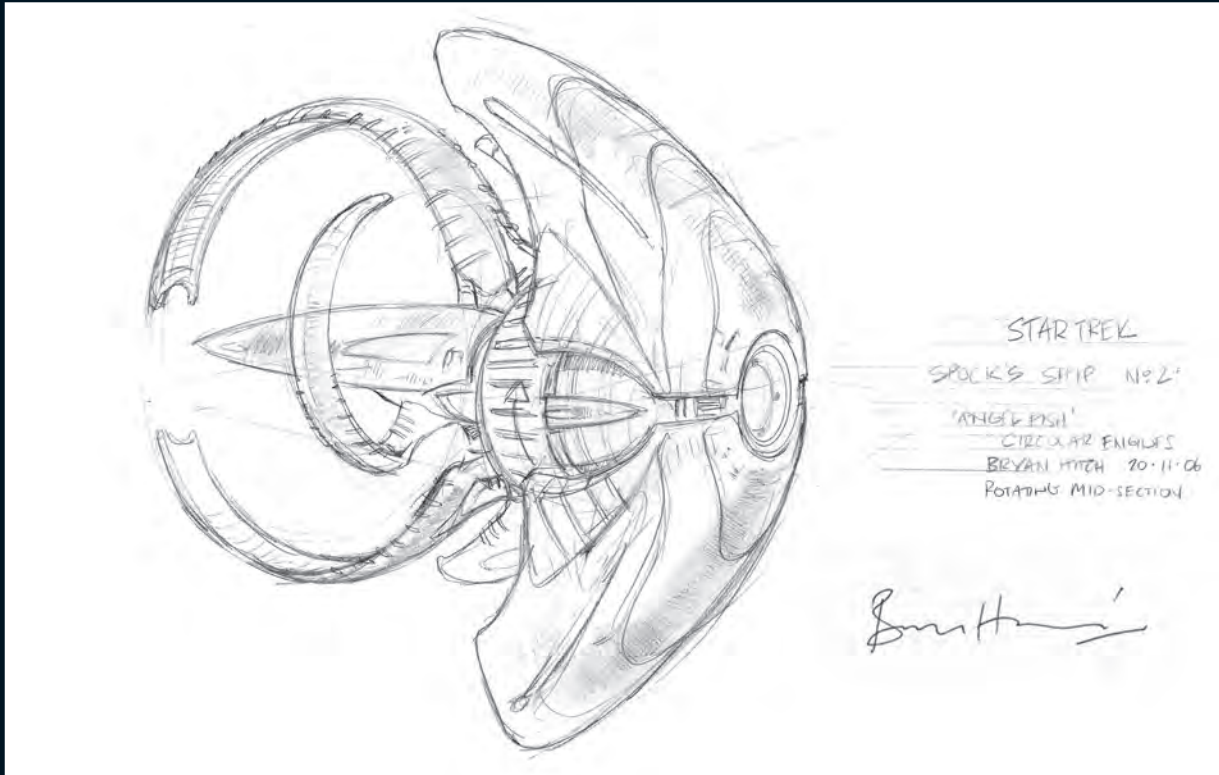

◀ Bryan Hitch labelled his favorite design for Spock's ship 'Angel Fish'. He always intended most of the parts to rotate around a single fixed point, which would later become the cockpit; at this point, Hitch thought it would be the red matter injector.



◀ The basic CG models were designed to show the ship from a variety of angles and to show how such a complex design might move in three dimensions.



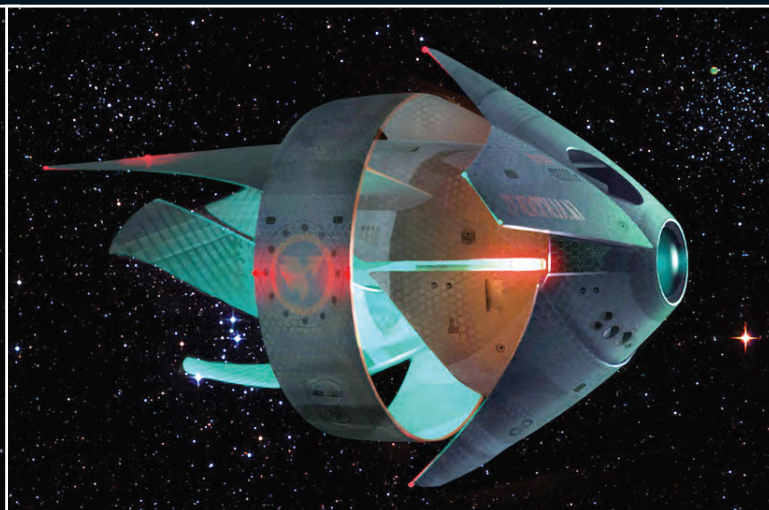

▲ Nathan Schroeder produced illustrations that showed a possible evolution of Hitch's initial design.

The other thing that Hitch wanted to do was to give the ship moving parts, something that – mostly due to budgetary constraints – *TREK* had never really achieved in the past.

"I loved *Voyager's* nacelles moving in that design," he says. "I wanted bits that turned and swung as the ship moved around a stable cockpit area." With this in mind, Hitch produced "four or five" sketches, only two of which survive. "The very first one I did I labeled 'Angel Fish,'" he says.

### STRANGE MOVEMENT

This drawing is remarkably close to the finished design, but it was only the first step on a long journey. As Hitch recalls, both he and Abrams were immediately pleased with it. "A rare first thought that seemed to work. I said I'd send several though so sketched up a few others. He liked two of them but *loved* the Angel Fish one (the coolest ship he'd ever seen, he said, and as a *Star Wars* fan I appreciated the compliment)."

Hitch describes the other design that Abrams liked as being like "an outboard motor," explaining that he came up with the idea because he was interested in the way its center of balance would effect its movement.

The next step was to work up the two designs that Abrams had identified, so Hitch sent the drawings to an old friend, and fellow *STAR TREK* fan, Neil Bushnell. "Bryan got in touch and asked me to create some 3D turnaround renders of his drawings. We'd become good friends watching the latest releases of *TNG* and *DS9* so I was delighted. At the time I was running an animation studio called *Quirios*, producing CGI for shows like

*Spooks* and *Hyperdrive*. Bryan sent through two designs suggesting very different directions for the ship. We created computer models with basic textures based on the drawings he sent. They were intended as discussion models, something to help them visualize the complex shapes, so we didn't go to town on producing finished textures."

These 'CG sketches' went back to Abrams and his team but at this point, as Hitch remembers, work started to slow down. "We spoke on the phone, and had a very long chat about design approaches to the whole *TREK* universe, how the *Enterprise* would function and move, scale, etcetera but there was no green light and we were a long time away from pre-production," Hitch recalls. "I was supposed to be part of the full design team. JJ asked me to stay with the film when or if that green light came but it was by no means certain it would. It was a year or so before the film finally went into production and due to several things, not least the birth of my son Ted the day Paramount greenlit the movie, I couldn't go out to work on it."

### THE NEXT PHASE

With Hitch unable to travel to LA, the design moved into a new phase, under the supervision of production designer Scott Chambliss. As Hitch remembers, he expected everything to change. "The production designer told me that my design would end up being drastically reworked..."

Chambliss explains that he was keen that every avenue would be left open. "I always give direction with conceptual conversation and visual reference material, but the real magic happens in



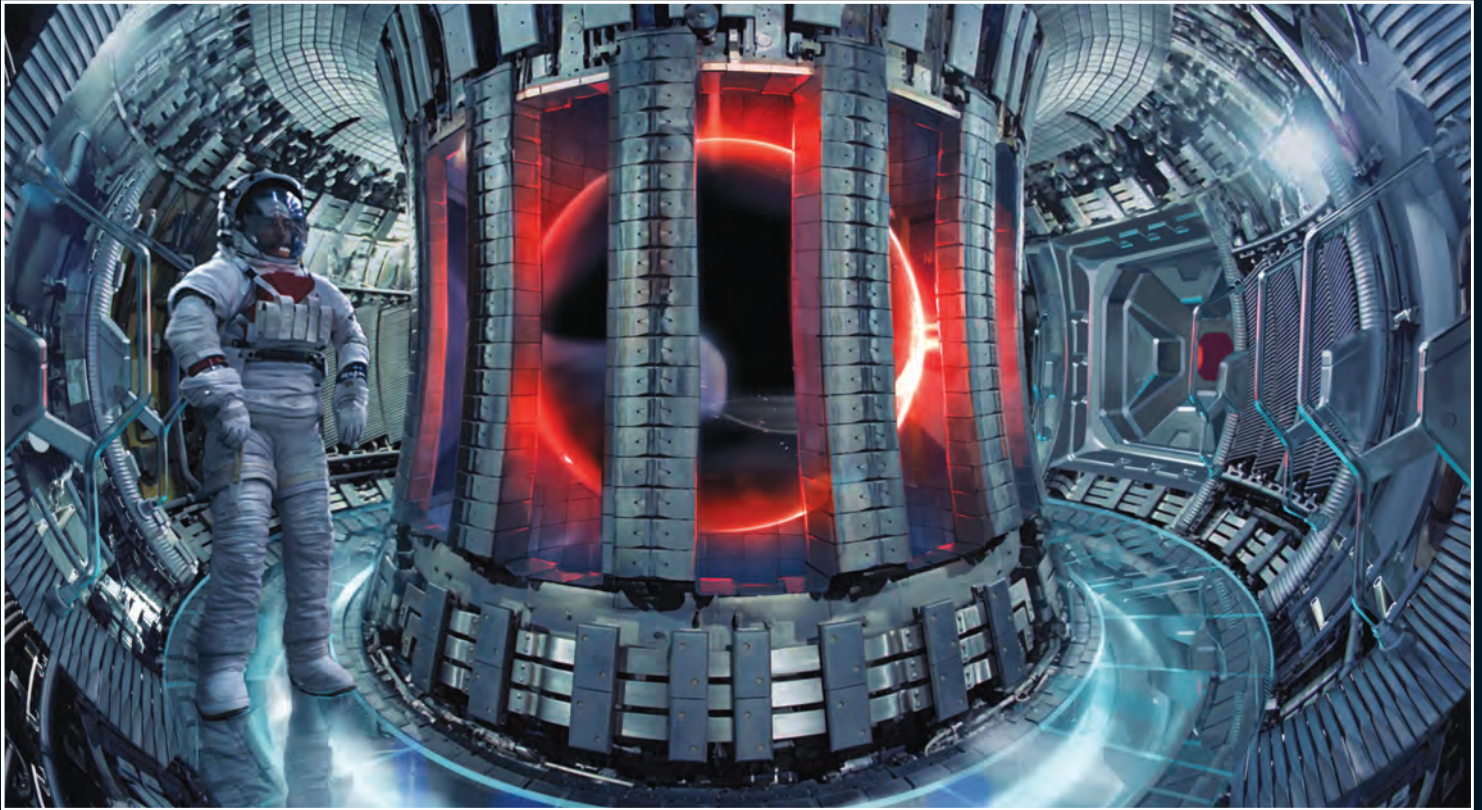

## Inside the **Jellyfish**

The same team that worked on the exterior of the Jellyfish produced the interior. Originally the script called for several locations: the cockpit, a transporter station (which was later cut) and a curved corridor that connected the cockpit to the red matter containment area.

As always Chambliss gave his illustrators a concept for the interior, in particular the cockpit. "I wanted it to be a visualization of neurons firing and synapses connecting in the form of the ship's inner technical workings," he says, "literally looking at

the brain of the ship with the information visually swirling all around Spock as he piloted it."

This time the work started with Nathan Schroeder, who remembers that he also had an idea that informed the design of the cockpit. "I did a little visual joke in the cockpit. The way the script originally read you didn't know this was Spock's ship. You saw the pilot from behind and you didn't know who this guy was. I was a fan from way back when of the old show. What I tried to do was to echo the Vulcan IDIC

symbol. There's a big circular window and he sits in the middle in a triangular chair, so it recreates the shape for the pendant. I thought this would be a nice bit of foreshadowing, for anyone who got it. But in the end you always knew it was Spock."

The final work on the design was done by Ryan Church, who worked up new concepts for the red matter chamber, which originally showed a mysterious figure in a spacesuit, designed an airlock, and finalised Schroeder's concept for the cockpit.





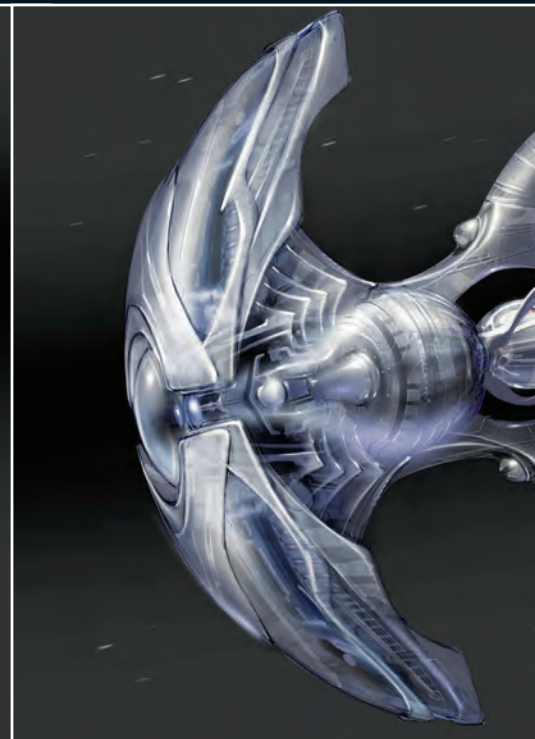

the collaboration process with my illustrators. That's the beauty and value of this job, and why I love it. When visual collaborators develop an articulate verbal language and inspire new thoughts in each other, we create something better, stronger, more beautiful together than we can manifest individually on our own. That to me is the addictive magic of movie making."

Chambliss also believes that it is important that

designs proceed from an idea and don't simply look cool, but have a reason behind why they look the way they do. He worked with Abrams to establish a Vulcan design ethic that would inform the ship's nature.

#### VULCAN IDEAS

"Our approach to the Vulcan culture was as straightforward as can be. Their society and

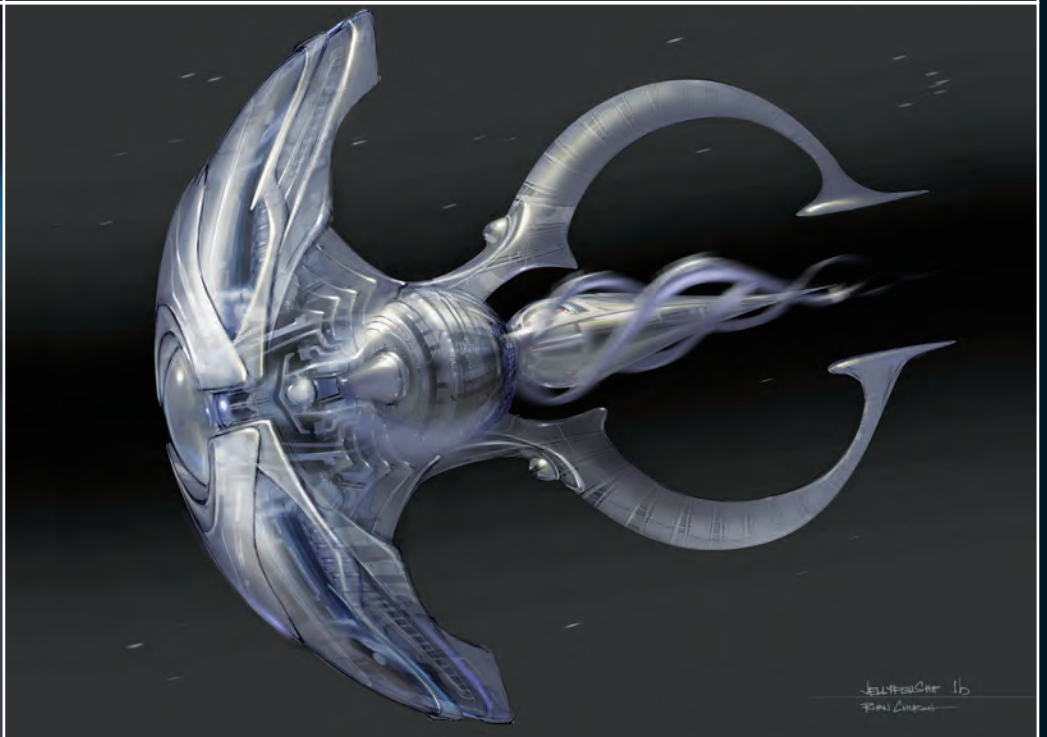
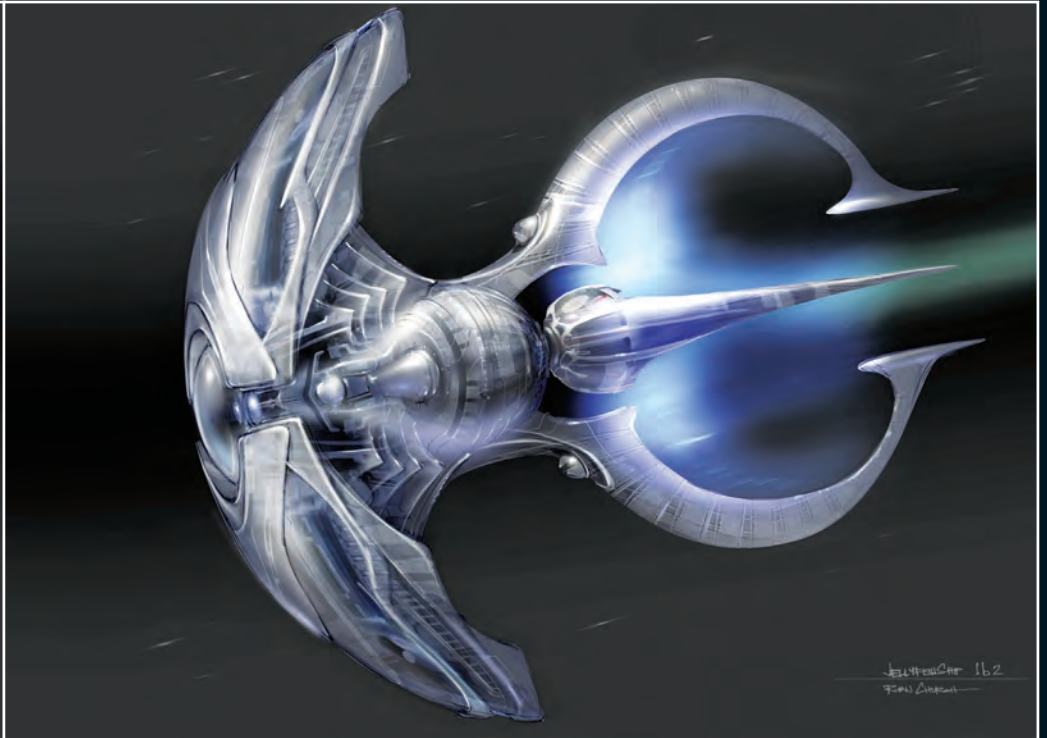

everything it produced was rooted in pure, unassailable logic. Whether or not the conclusions drawn from their logical processes produced ultimate truths as a result remains an open question. For the Jellyfish ship we wanted a craft engineered with deep understanding of both man-made technological/mechanical principles as well as nature's design and processes. We wanted to make this little one-person vehicle

utterly distinctive from the rest of our collection, and even a little bit (don't tell Spock) fun. Whether any of those notions were successfully conveyed is to be determined by others... which makes the design of the Jellyship authentically Vulcan!"

The first concept artist that Chambliss set to work on the design was Nathan Schroeder, who was given Hitch's sketch and started to work it up into a more finished design.

▲ A selection of Ryan Church's early 'sketches' for Spock's Jellyfish ship. At this point, Church was looking at ways of developing Hitch's initial idea, but many of these designs felt too much like real sea creatures.



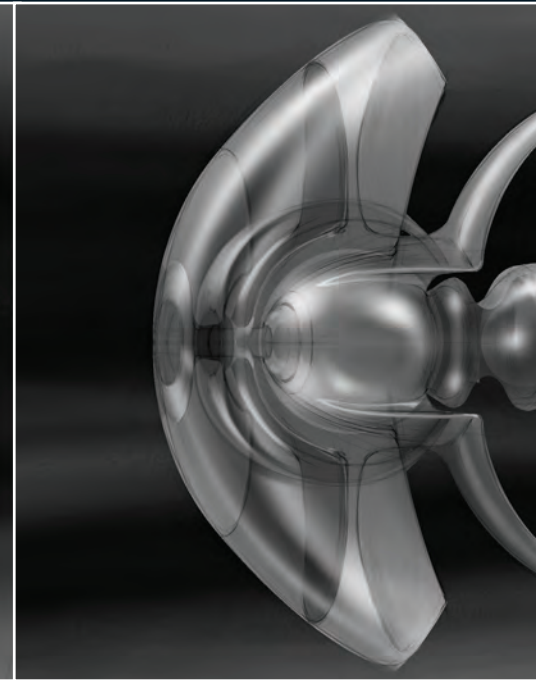
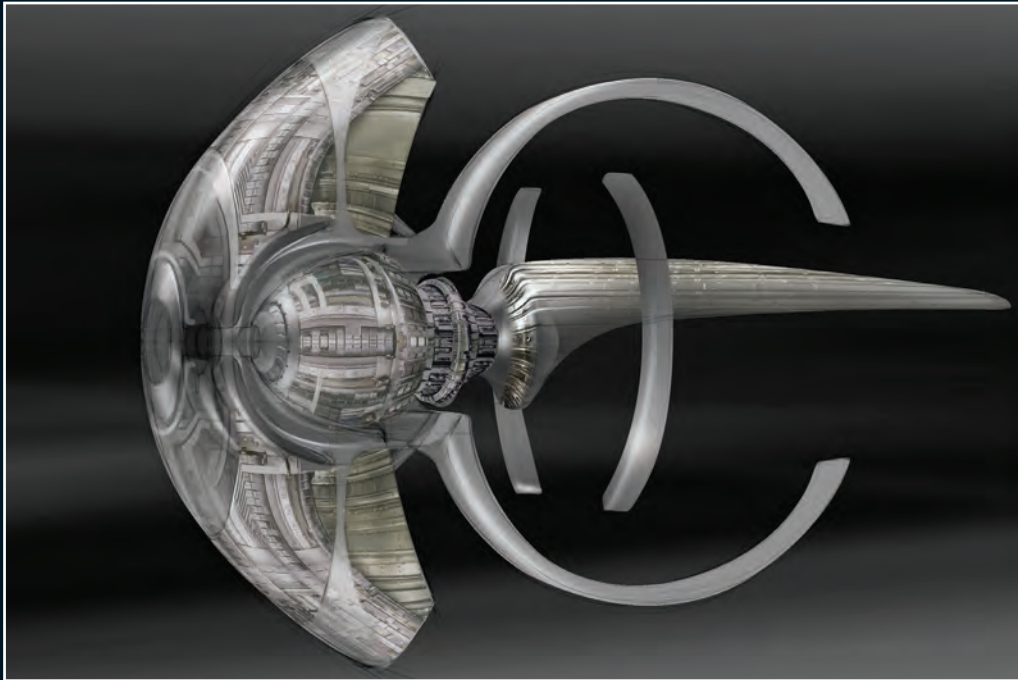

"It was pretty early in the design phase," Schroeder remembers. "The pencil sketch was a starting point. They wanted it to have some kind of locomotion device that was somewhat mysterious and not necessarily easy to comprehend. I came up with a design with some kind of turbine in the middle." Schroeder would also play a major role in designing the interior of the ship but he then moved on to work on a different movie and wasn't able to continue working on the Jellyfish.

A little later on, Ryan Church started work on another set of concepts for the ship. "His first designs were less directly an interpretation of sea life," Chambliss explains, "as Bryan had already covered that angle."

#### ENTER RYAN CHURCH

As Church recalls, by the time he saw the script, Hitch's scribbled name – the Angel Fish – had become attached to the ship, but somewhere

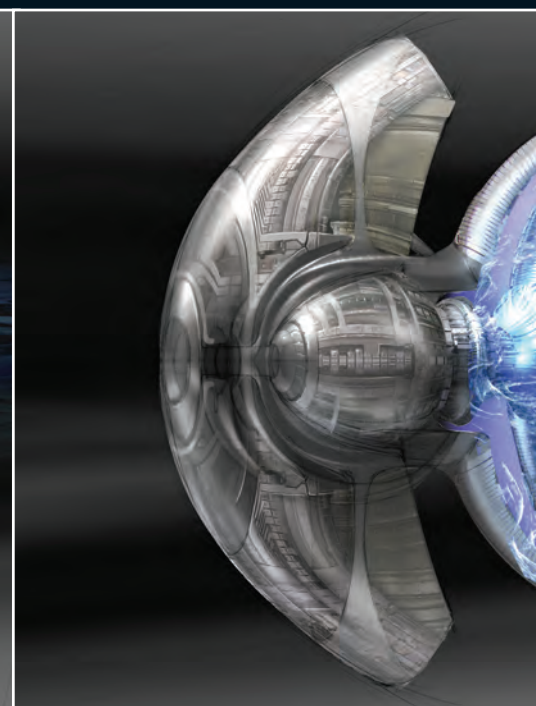
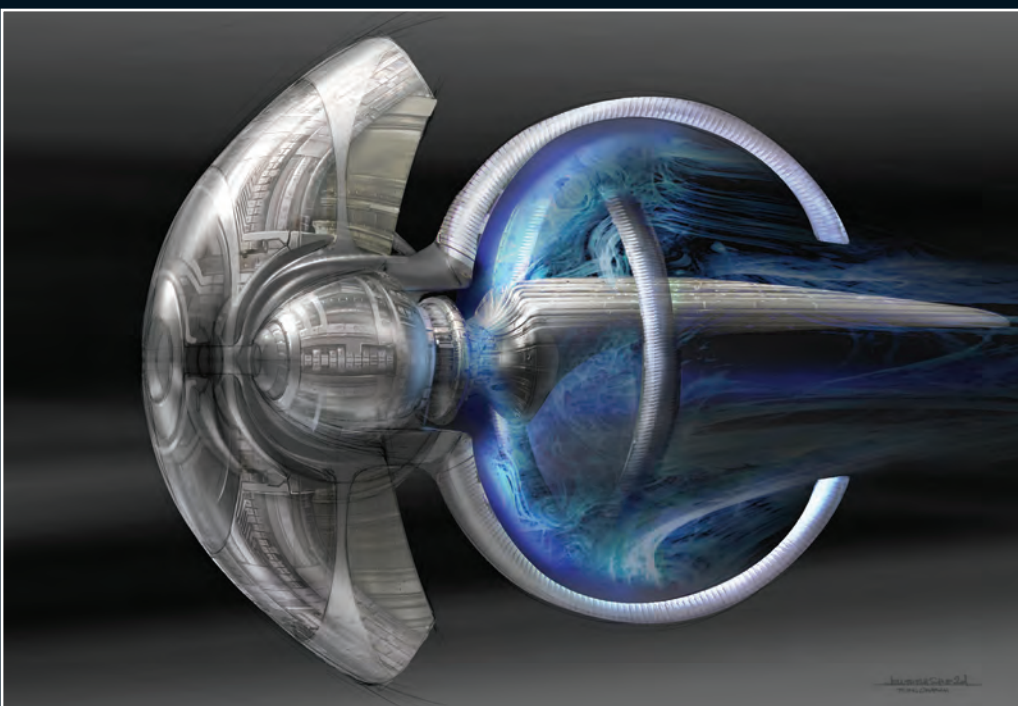

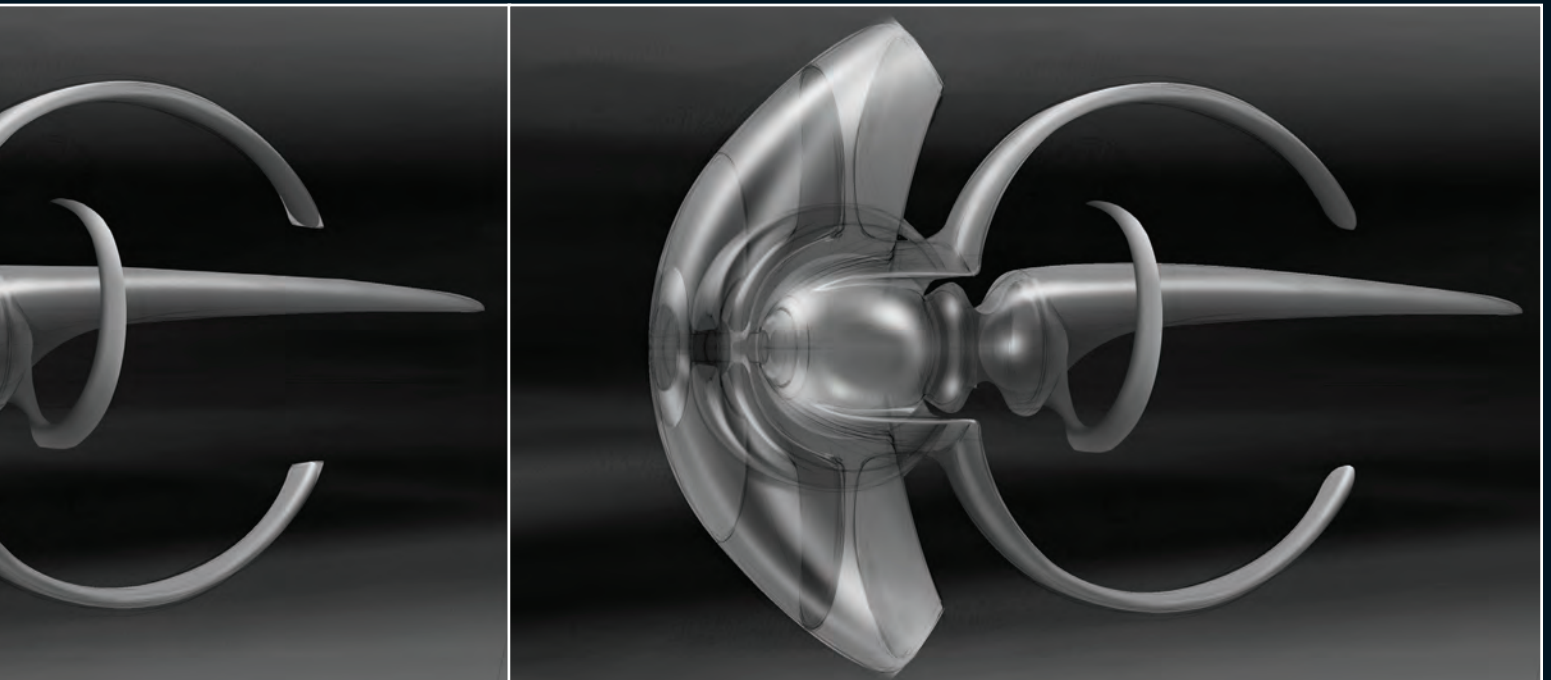

along the line had transformed in to the Jellyfish. "I first read the script in JJ's office and I remember the 'Jellyfish ship' name really jumped out at me. From that first thought I pictured something very transparent and ethereal, which made sense in that this ship's purpose was to be something very different, very advanced even for the Vulcans to be making.

"Scott gave me an early brief just to do something that looked different than any other

ship I'd seen – something completely alien. I did a few quick sketches in very early JJ meetings. My intent was always to go back and work them up but I was busy working on the *Kelvin* and the *Enterprise* and things had changed before I ever got back to them."

According to Church, those sketches included some radical departures, including a cube of pure energy. Abrams, however, wanted the ship to have as much character as Spock did himself, and,

▲ Church's next round of sketches experimented with different surface textures, many of which were slightly transparent like a real jellyfish, and showed the Vulcan technology under the organic skin.

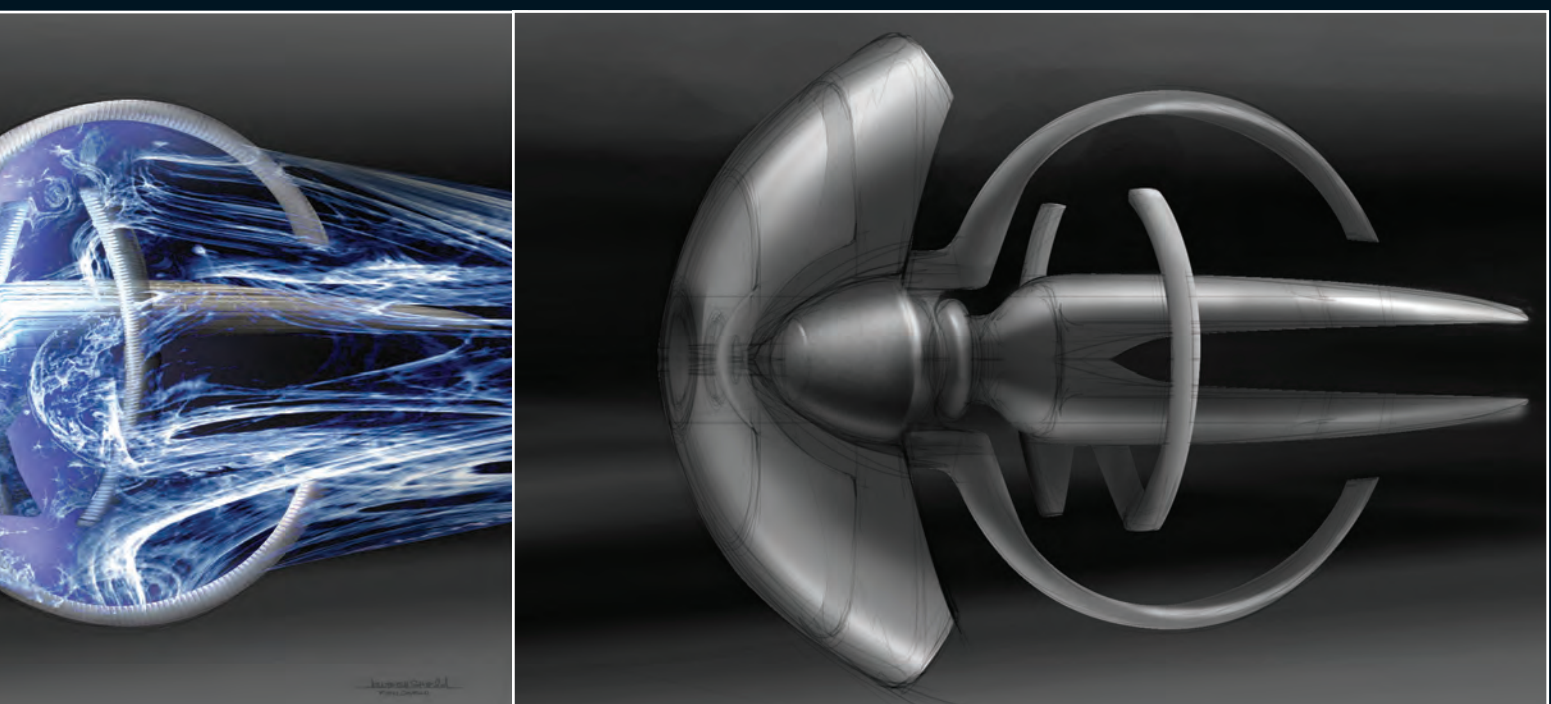



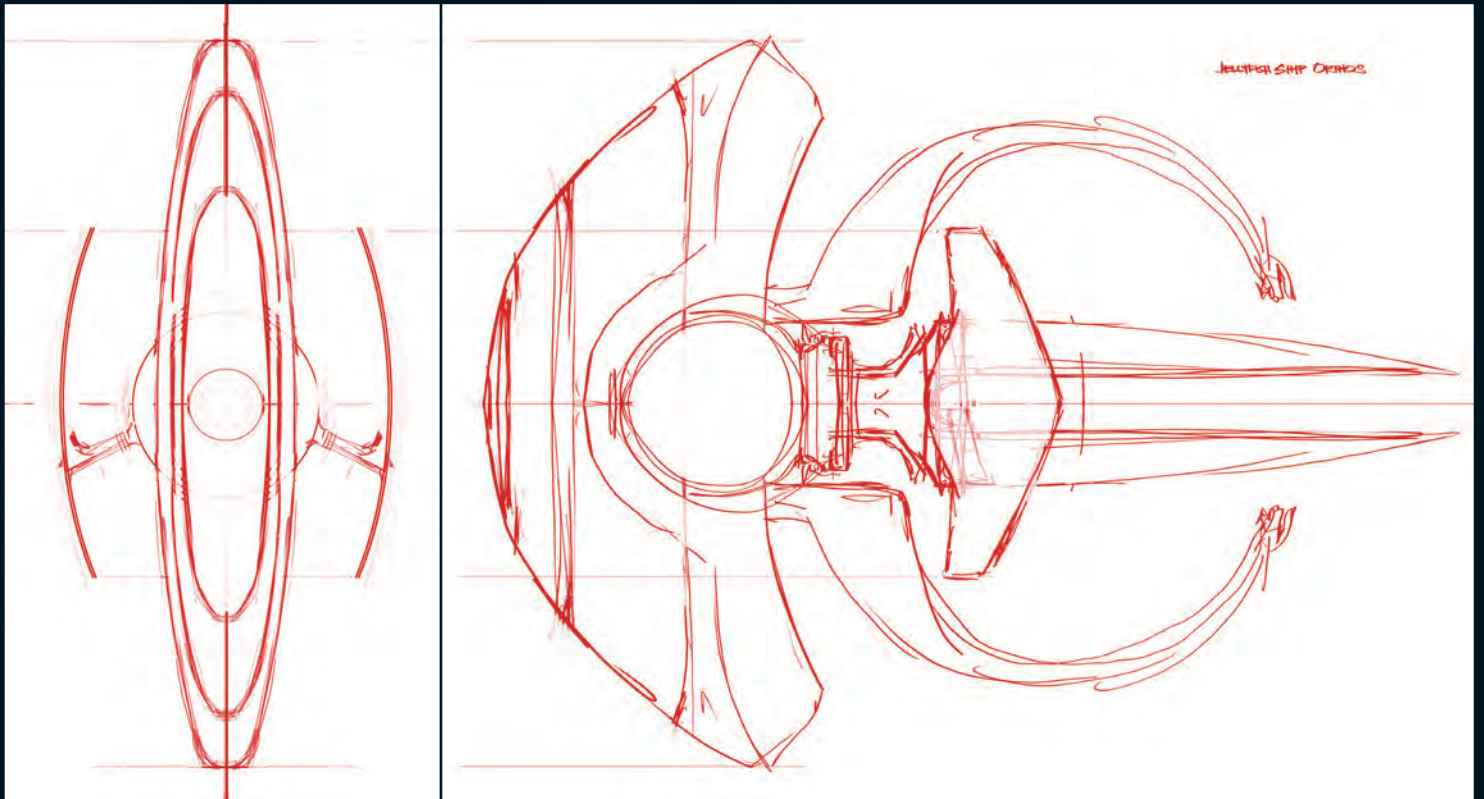

▲ After Church's second round of sketches the final shape was locked down and Church produced this sketch showing the plan views.

▼ Joe Huiru took Church's sketches and produced a basic 3D model for the producers to study.

having explored the alternatives, he pulled the team back toward Hitch's original sketch.

#### BACK TO THE JELLYFISH

"Bryan was a great interpreter," Chambliss says, "and the Jellyfish was our favorite of his options. It had a sustaining influence on our final design. One of JJ's specifics was that he wanted the gyroscopic movement that you see when the ship is flying, which he thought would be a great visual

dynamic for the piece. There was a mechanical believability to the bones of his interpretation which put us on our path to the final product."

So when Church finally returned to work on the project, he took Hitch's design as his starting point. "When we got Bryan's sketch, Scott wanted to try some variations to further flesh them out and have options to show JJ during our meetings." As usual Church started to produce digital illustrations that showed variations of the same basic design.

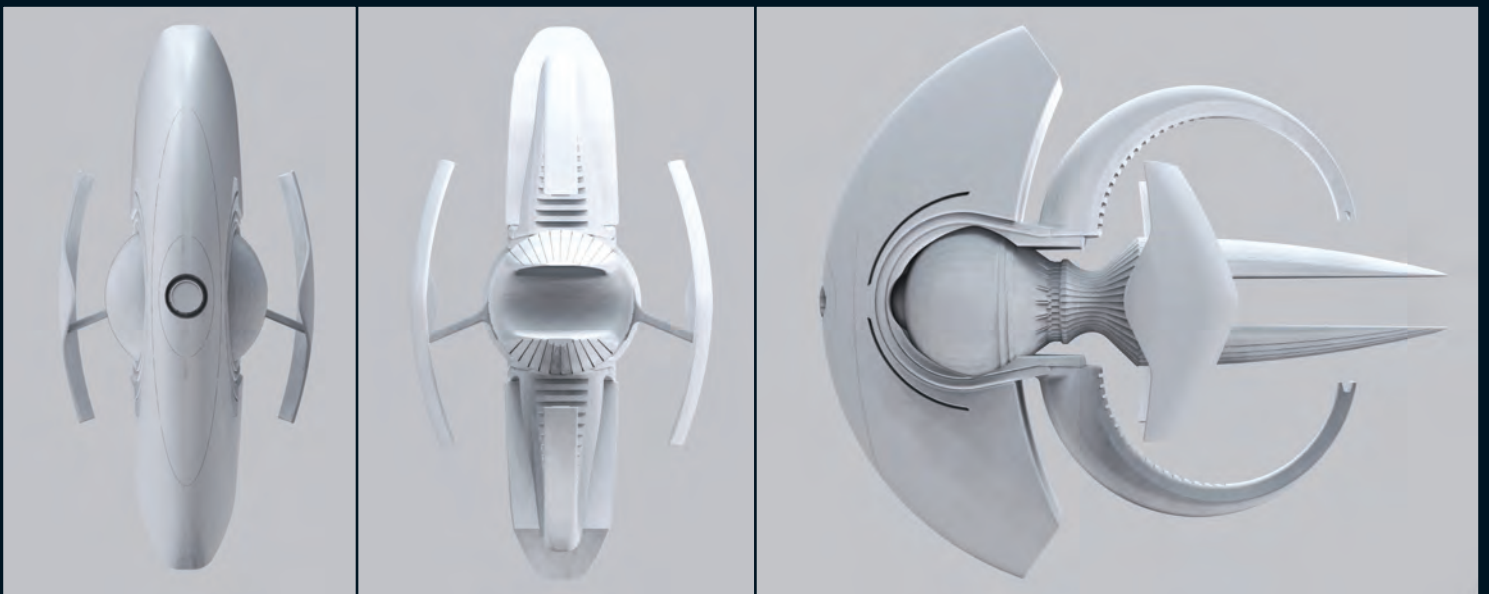

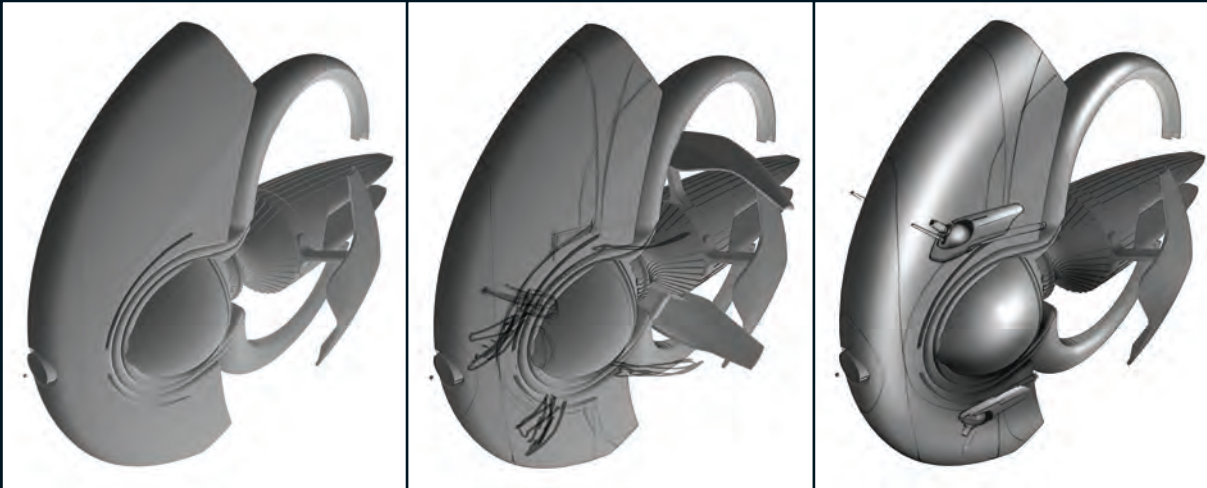

▶ Joe Hiura worked up a simple CG model based on Church's design, and the production team looked at ways it could be improved, including the introduction of weaponry.

His first round consisted of eight versions, which all maintained the same basic shape but explored different approaches to the surface texture and in particular the shape of the tail and method of propulsion. "The goal with these variations," Church says, "was to try different material passes, different complexities, different ways of making the design look more real. There are tail variations that make the design more 'jellyfish' like. We were also thinking of different ways to portray the engine exhaust or propulsion technique. We tried different things but we always knew we didn't want a conventional glowing exhaust."

"Some of the versions I looked at were going for a more organic look, I knew that in the movie we would have a flashback showing it being built and I wanted to do something to differentiate it from the *Enterprise* being built, so I pushed the idea that this very organic ship was in fact 'grown' in some way to make it's creation completely distinct from what we were seeing with the *Enterprise*."

Chambliss and Abrams felt that some of these designs were taking the jellyfish idea a little too literally and that this was causing problems because they were going in a similar direction with Nero's ship, the *Narada*.

▼ This James Clyne painting shows the Jellyfish ship being constructed on Vulcan.





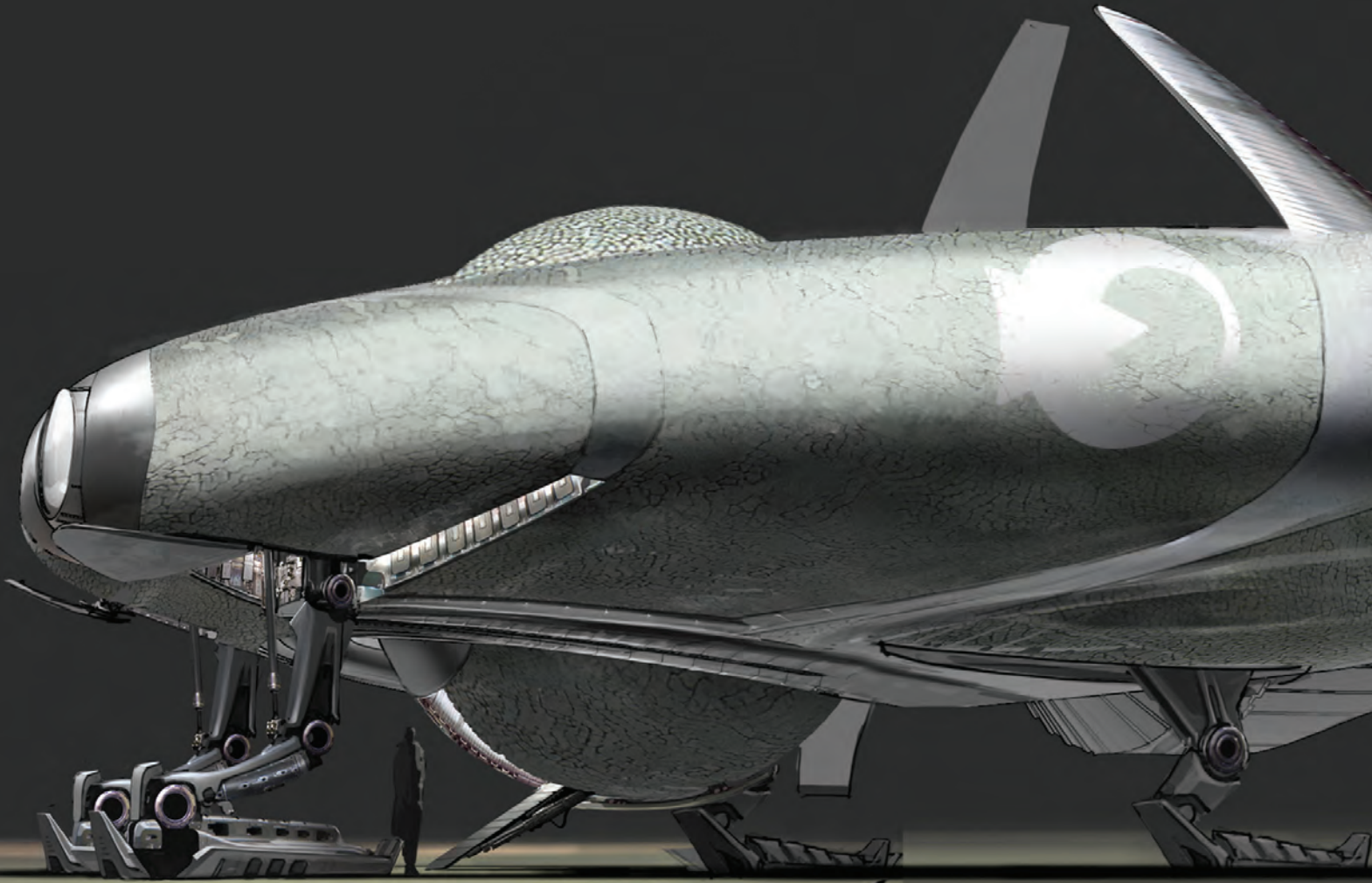

▲ Working out how the ship would land, presented something of a challenge. Because it was vertical, the cockpit would have been a long way off the ground. The solution was to turn it on its side.

“We were searching for our foundations in these early ideas,” Chambliss explains, “and it quickly became clear that the more sea creature-ish the ship was, the more it weakened the design approach of the *Narada*. They both seemed to become sea creatures when viewed together. It didn’t take much development time to realize this, and to switch the emphasis of the Jellyfish.”

#### FINAL EVOLUTION

Church’s next round of concepts, another set of eight, moved away from the more obviously organic approach, while continuing different looks for the engines. “In a few of my versions,” Church says, “I thought of the large curved pieces as holding some sort of dimensional distorter, something that looked like a soap bubble stretched over a curved shape.”

Although the design was moving away from anything that looked too much like a literal sea

creature, Church was still experimenting with making large parts of the exterior translucent like a real jellyfish. Finding the right texture would be the final key to the design. As Chambliss explains, he was keen on the idea that Vulcan technology was somehow grown rather than manufactured by traditional means. “I wanted to discover how we could literally unite nature with a machine in a fundamental and necessary way with the Jellyfish.”

#### STRANGE TEXTURES

Church continues, “I kept reintroducing and reminding myself about the transparency aspect. We did some unpainted metal versions and other things. I remember Scott arrived at the ‘green pebble scale’ type texture that’s in the final design and in some of my illustrations. When he first suggested that I admit I thought it was an odd direction but it looks great and the thinking is that it serves some type of ‘ablative insulation’ function



to protect the ship from its unique stresses and loads.”

For Chambliss, the point about the texture was that it provided a uniquely Vulcan approach to the final design, one that suggested the ship could have been ‘grown’. “The textural exploration was a journey toward making the hard shell of the Jellyfish an actual grown, living skin that has hardened to become virtually impermeable, a concept borrowed from nature and elaborated upon.”

By this point both the shape and the texture had been more or less locked down. There were some experiments in which the ship gained obvious guns mounted on the outside, something Chambliss describes as “inevitable” with science fiction.

#### ON THE GROUND

The other major consideration was how the ship would land. “It’s always a challenge to put landing gear on a vertically oriented ship,” Church says. “I did a few versions that showed ways to do this and how to get in and out of the thing, knowing that in this case the set builders were going to actually construct the stairs going up and into the ship. That affected the way the tail and spinning parts moved: once we decided the landing orientation we had to be mindful of that and be sure there was a ‘landed configuration’ that looks like it makes sense and can actually look right.”

The eventual solution was to turn the ship on its side and build a ramp into the ‘bottom’ – though ‘side’ and ‘bottom’ were meaningless concepts on a ship where the cockpit stayed stationary and everything else rotated.

The final design that was sent over to ILM, where it was built as a CG model, was remarkably close to Hitch’s original sketch. Something which he says came as a great surprise to him.

“Ryan Church did a beautiful job fleshing out the structure and giving it texture and it moved exactly as we’d envisaged. Honestly, it’s very rare for a design to be carried through a long process like this and maintain its integrity. So when I saw the movie it was surprising to see just how much made it through all that to the finished film. Getting to work on *TREK*, let alone contribute something like Spock’s ship to the mythology, has been a dream come true.”



◀ The production team knew that although the ship would be built in CG, the ramp that led up to it would have to be constructed on the soundstage.



# STAR TREK™

